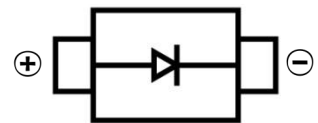

SCHOTTKY BARRIER DIODE
FEATURES

- Small Surface Mount device
- Low power loss, high efficiency
- High temperature soldering guaranteed:260°C/10 seconds at terminals
- Guard ring for over voltage protection
- For use in low voltage high frequency inverters, free wheeling, and polarity protection applications

SMA
MECHANICAL DATA

- Case: SMA(DO214AC)
- Case Material: Molded Plastic. UL flammability
- Classification Rating: 94V-0
- Weight: 0.065grams (approximate)

MAXIMUM RATINGS (T_A = 25°C unless otherwise noted)

Parameter	Symbol	SS32A	SS33A	SS34A	SS36A	SS38A	SS310A	SS315A	SS320A	Unit
Repetitive peak reverse voltage	V _{RRM}	20	30	40	60	80	100	150	200	V
DC Reverse Voltage	V _R	20	30	40	60	80	100	150	200	V
RMS Reverse Voltage	V _{RMS}	14	21	28	42	56	70	105	140	V
Non-Repetitive Peak Forward Surge Current @ t = 8.3 ms	I _{FSM}	80								A
Mean rectifying current	I _F	3.0								A
Thermal Resistance	R _{θJA}	85								°C/W
Junction Temperature	T _J	150								°C
Storage Temperature	T _{STG}	-55 ~+175								°C

ELECTRICAL CHARACTERISTICS (T_A = 25°C unless otherwise specified)

Parameter	Symbol	SS32A	SS33A	SS34A	SS36A	SS38A	SS310A	SS315A	SS320A	Unit	Conditions
Forward voltage	V _F	0.5		0.7	0.85		0.9	0.92		V	I _F =3A
Reverse current T=25°C	I _R	0.5								mA	V=V _R
Reverse current T=100°C	I _R	20								mA	
Junction capacitance	C _J	160								pF	V=4V,f=1MHz

SCHOTTKY BARRIER DIODE

Typical Characteristics

FIG. 1 FORWARD CURRENT DERATING CURVE

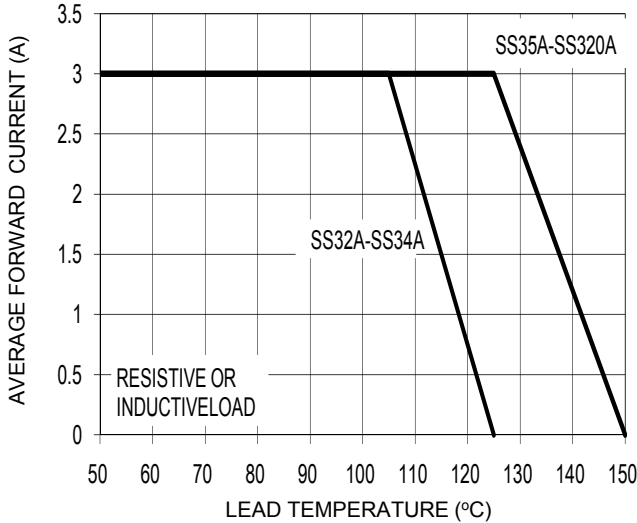

FIG. 2 MAXIMUM NON-REPETITIVE FORWARD SURGE CURRENT

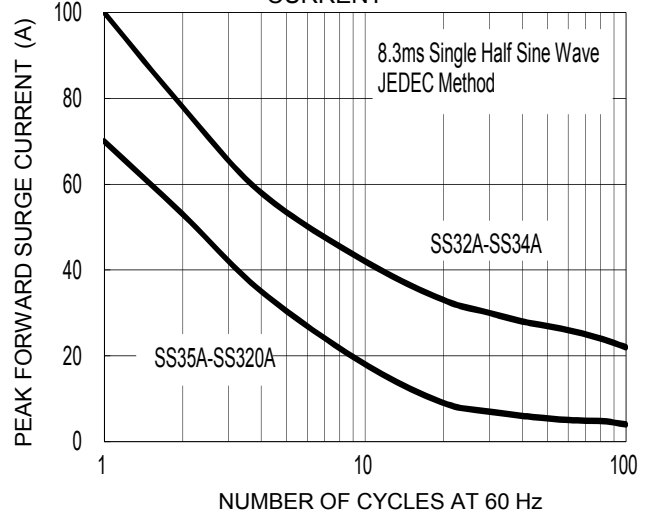

FIG. 3 TYPICAL FORWARD CHARACTERISTICS

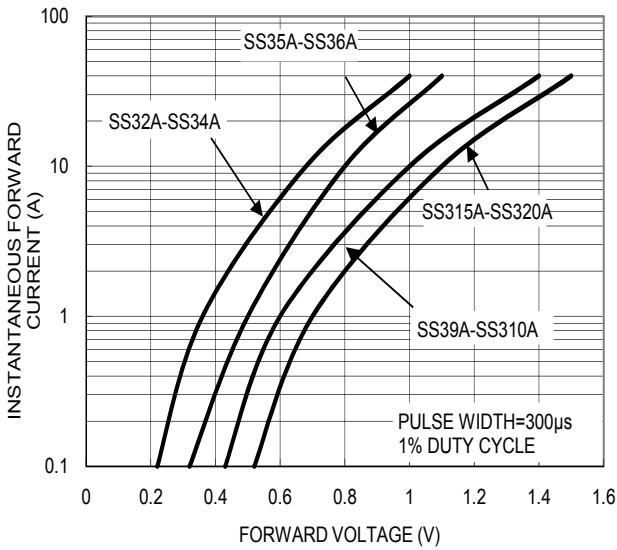

FIG. 4 TYPICAL REVERSE CHARACTERISTICS

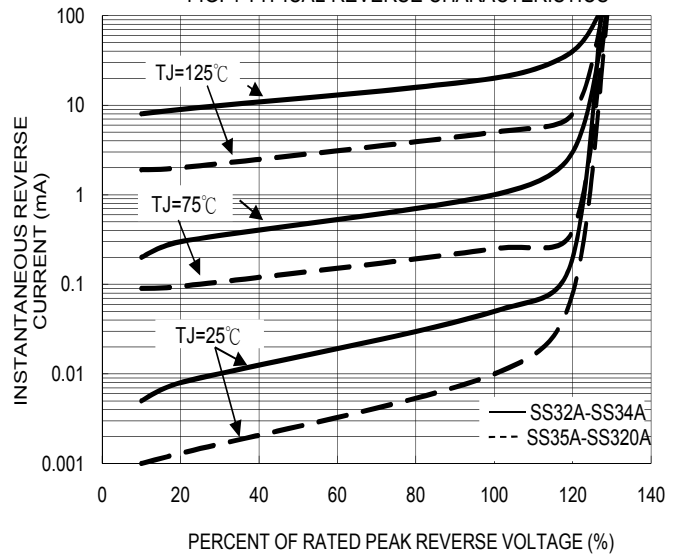

FIG. 5 TYPICAL JUNCTION CAPACITANCE

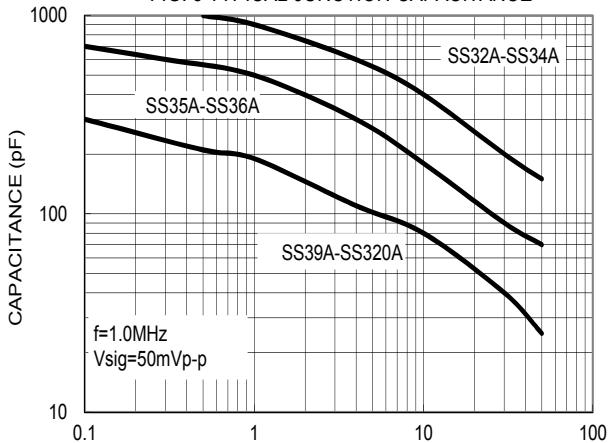
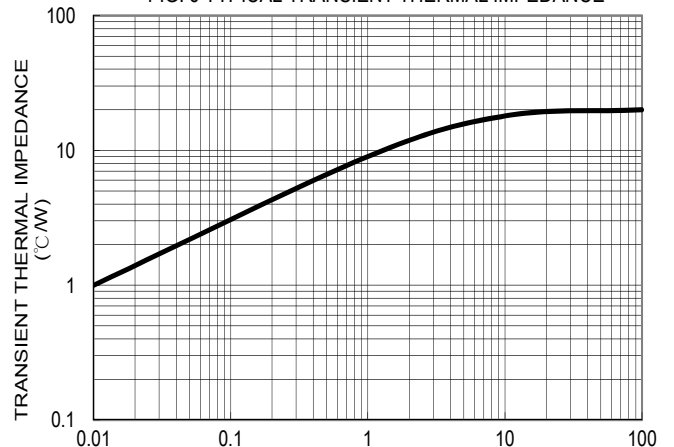
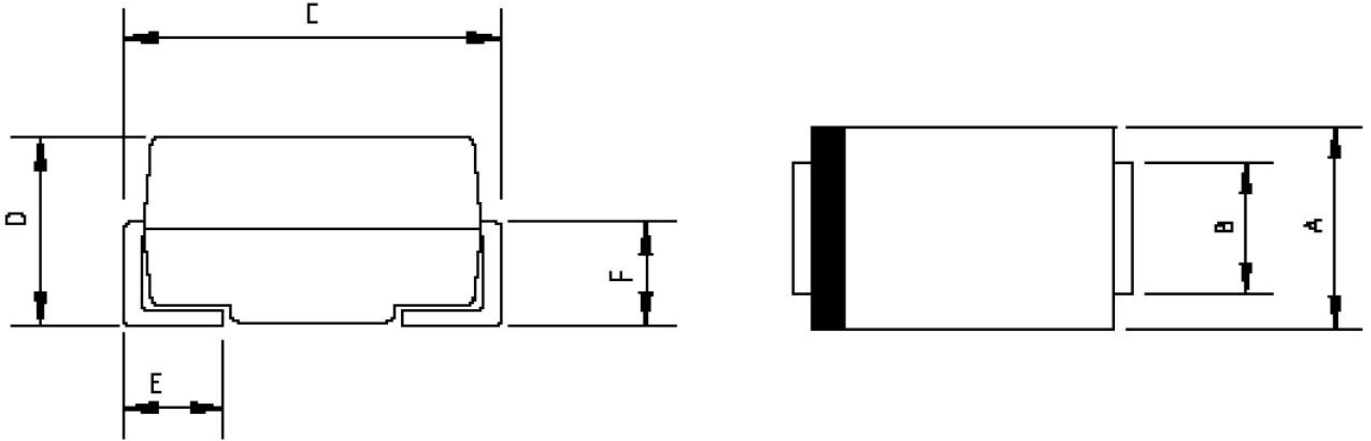

FIG. 6 TYPICAL TRANSIENT THERMAL IMPEDANCE



SCHOTTKY BARRIER DIODE

SMA Package Outline Dimensions



Symbol	Dimensions In Millimeters		Dimensions In Inches	
	Min.	Max.	Min.	Max.
A	2.20	2.80	0.086	0.110
B	1.30	1.70	0.051	0.067
C	4.70	5.30	0.185	0.209
D	1.70	2.55	0.067	0.100
E	0.90	1.50	0.035	0.059
F	0.90	1.50	0.035	0.059

SMA Suggested Pad Layout

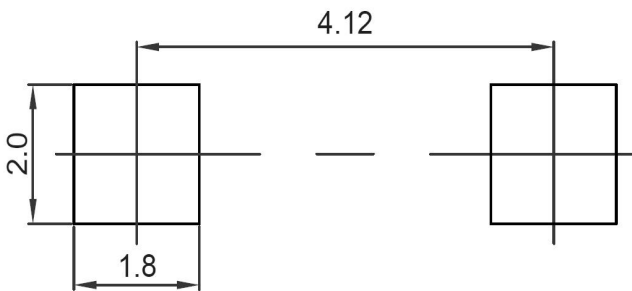

Note:

1. Controlling dimension: in millimeters
2. General tolerance: $\pm 0.05\text{mm}$
3. The pad layout is for reference purposes only

SCHOTTKY BARRIER DIODE

SMA Tape and Reel

SMA Embossed Carrier Tape

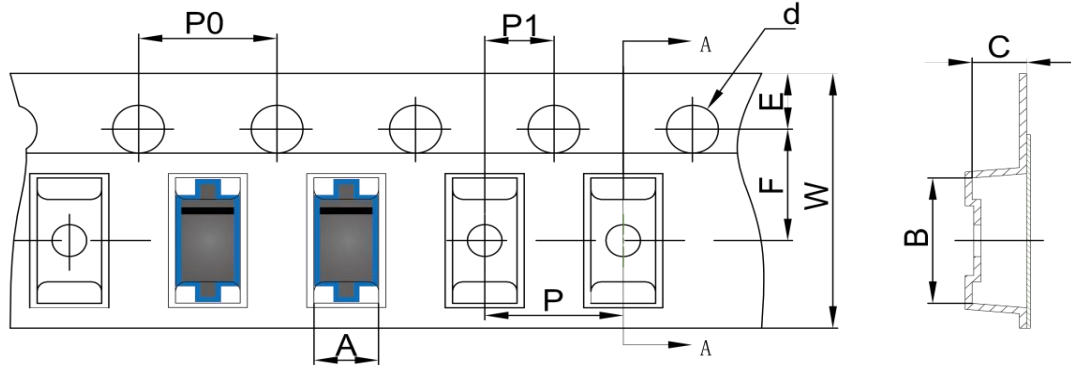

DIMENSIONS ARE IN MILLIMETER										
TYPE	A	B	C	d	E	F	P0	P	P1	W
SMA	2.89	5.35	2.68	Ø1.50	1.75	5.50	4.00	4.00	2.00	12.00
TOLERANCE	±0.1	±0.1	±0.1	±0.1	±0.1	±0.1	±0.1	±0.1	±0.1	±0.1

SMA Tape Leader and Trailer

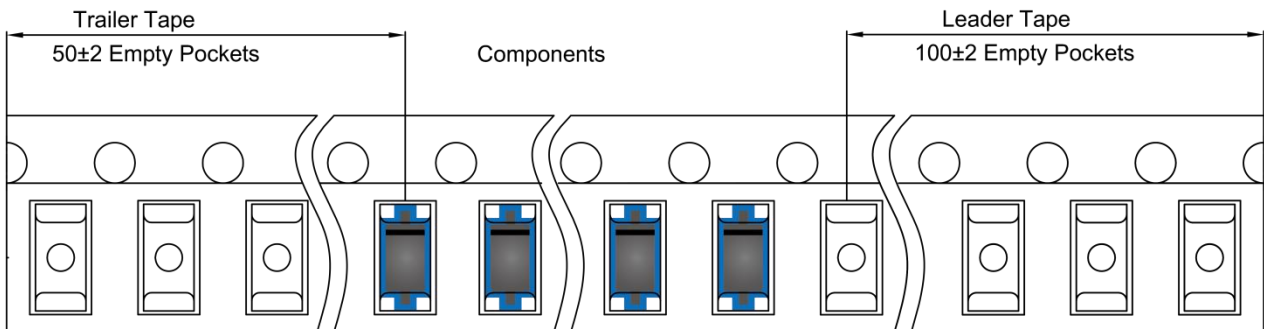

SMA Reel

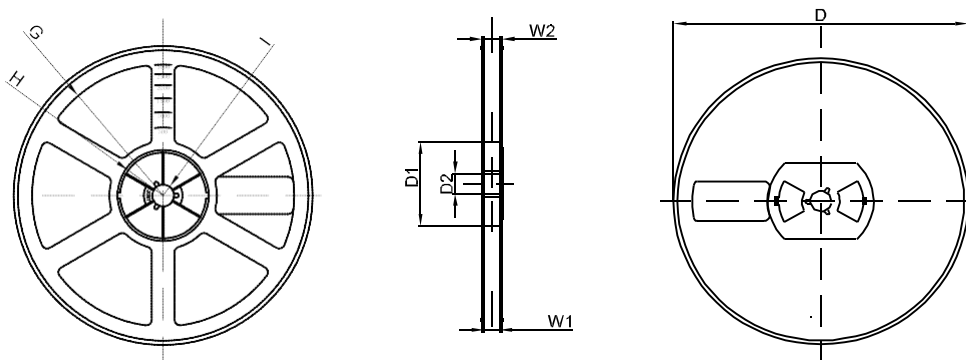

DIMENSIONS ARE IN MILLIMETER								
REEL OPTION	D	D1	D2	G	H	I	W1	W2
7" DIA	Ø178	54.40	13.00	R78	R25.60	R6.50	12.40	17.60
TOLERANCE	±2	±1	±1	±1	±1	±1	±1	±1