

# User Manual

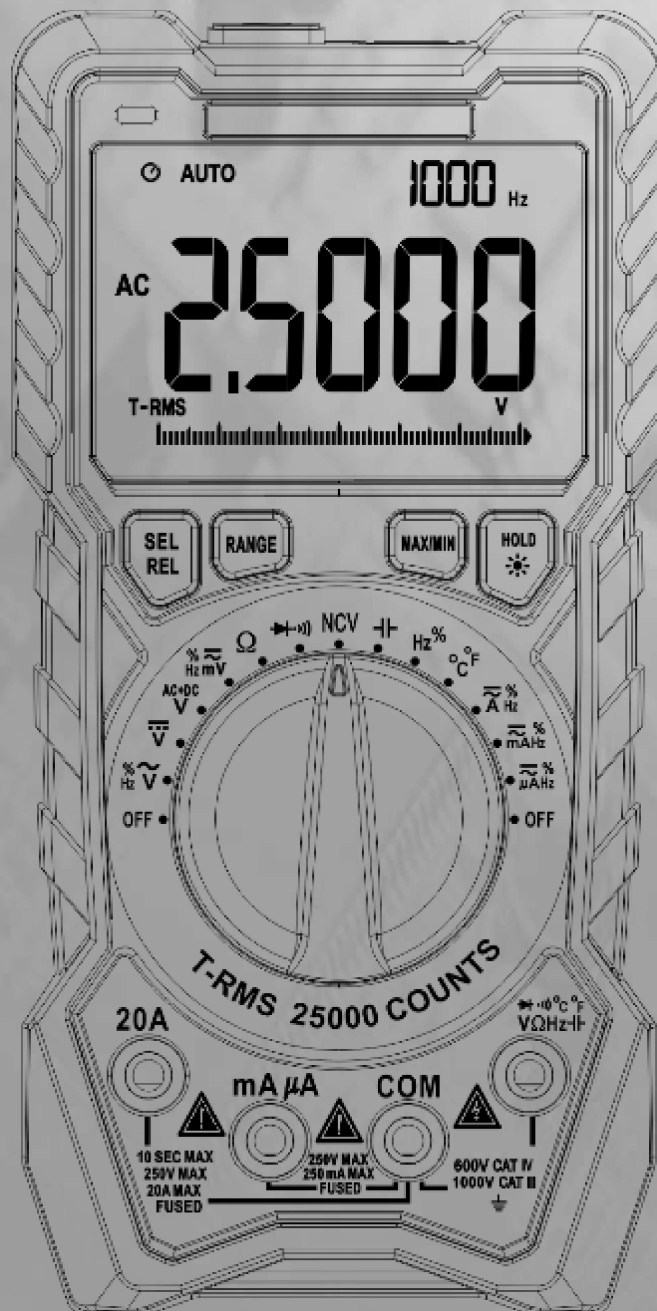

## *LIMITED WARRANTY AND LIMITATION OF LIABILITY*

Customers enjoy one-year warranty from the date of purchase.

This warranty does not cover fuses, disposable batteries, damage from misuse accident, neglect, alteration, contamination, or abnormal conditions of operation or handling, including failures caused by use outside of the product's specifications, or normal wear and tear of mechanical components.

# *Table of Contents*

*Page*

Introduction.....	1
Safety Information.....	1
Instrument Overview.....	3
<i>LCD Display</i> .....	3
<i>Function Buttons</i> .....	5
<i>Rotary Switch</i> .....	7
<i>Input Terminals</i> .....	10
Measurements Instruction.....	11
<i>Measure AC/DC Voltage</i> .....	11
<i>Measure AC/DC Current</i> .....	11
<i>Measure Resistance</i> .....	12
<i>Test for Continuity</i> .....	13
<i>Test Diodes</i> .....	13
<i>Measure Capacitance</i> .....	14
<i>Measure Frequency</i> .....	15
<i>Measure Duty Cycle</i> .....	15
<i>Measure Temperature</i> .....	16

NCV.....	16
AC+DC Voltage.....	17
Maintenance.....	18
<i>Clean the Product</i> .....	18
<i>Replace the Batteries</i> .....	18
<i>Replace the Fuses</i> .....	19
Specifications.....	19
<i>General Specifications</i> .....	19
<i>Mechanical Specifications</i> .....	20
<i>Environmental Specifications</i> .....	20
Electrical Specifications.....	21

## **Introduction**

This product is a battery-powered, true-rms, auto-ranging digital multimeter with a 25000 counts LCD display and a backlight.

## **Safety Information**

To avoid possible electrical shock, fire, or personal injury, please read all safety information before you use the product. Please use the product only as specified, or the protection supplied by the product can be compromised.

- Examine the case before you use the product. Look for cracks or missing plastic. Carefully look at the insulation around the terminals.
- The measurement must be made with correct input terminals and functions and within the allowable measuring range.



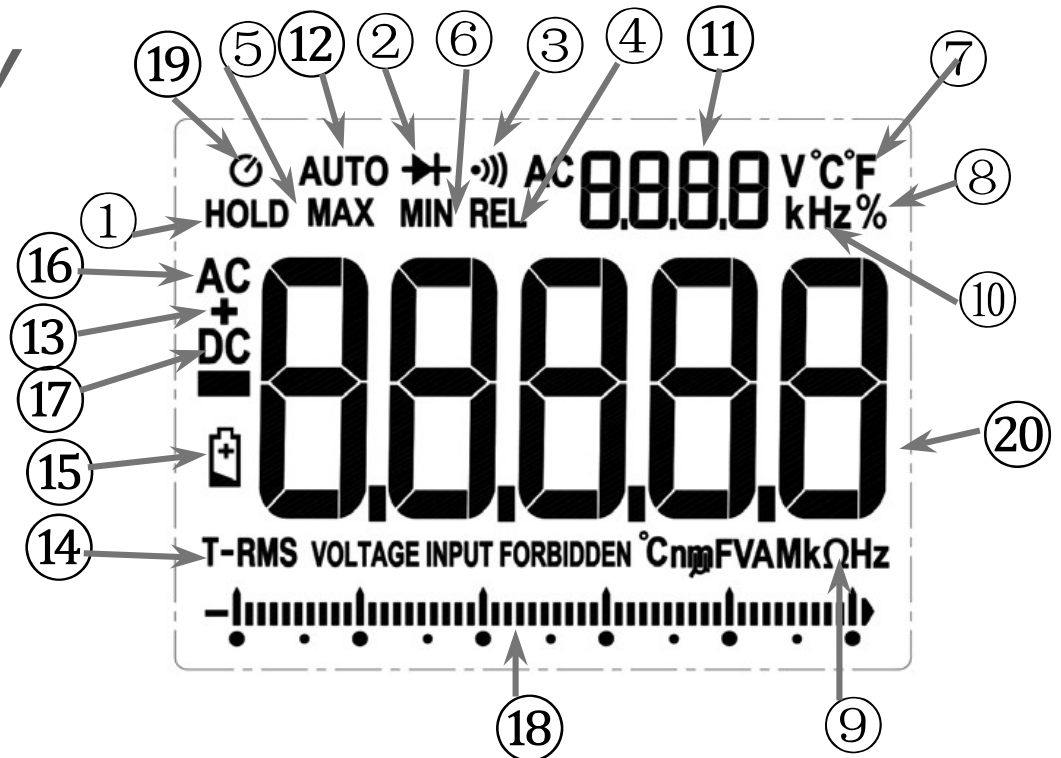

- Do not use the product around explosive gas, vapor, or in damp or wet environments.
- Keep fingers behind the finger guards on the probes.
- When the product has already been connected to the line being measured, do NOT touch the input terminal that is not in service.
- Disconnect the test leads from the circuit before changing the mode.
- When the voltage to be measured exceeds 36V DC or 25V AC, the operator shall be careful enough to avoid electric shock.
- Misuse of mode or range can lead to hazards, be cautious. “OL” will be shown on the display when the input is out of range.
- Low level of a battery will result in incorrect readings. Change the batteries when battery level is low. Do not make measurements when the battery door is not properly placed.

# Instrument Overview

## LCD Display



①	<b>HOLD</b>	Display freezes present reading.
②	<b>▶+</b>	Diode test.
③	<b>)))</b>	Continuity test.
④	REL	Relative value test.
⑤	<b>MAX</b>	Display shows maximum reading.
⑥	<b>MIN</b>	Display shows minimum reading.
⑦	<b>°F °C</b>	Temperature test. (Fahrenheit/Celsius)
⑧	<b>%</b>	Duty cycle test.

⑨		Resistance test. (Ohm)
⑩	<b>Hz</b>	Frequency test. (Hertz)
⑪	<b>0.0.0.0</b>	Secondary measurements display
⑫	<b>AUTO</b>	Auto range. The product selects the range with the best resolution.
⑬	<b>+</b>	AC + DC
⑭	<b>T-RMS</b>	The product can accurately measure alternating current with and without sinusoidal waveforms
⑮		Low battery. Replace batteries.
⑯	<b>AC</b>	Alternating current.
⑰	<b>DC</b>	Direct current.
⑱		Analog bar graph
⑲		Auto power off
⑳	<b>0.0.0.0.0</b>	Main display
<b>VOLTAGE INPUT FORBIDDEN</b>		Don't input voltage reminder.
<b>n k M <math>\mu</math> m</b>		Measurement units.



# Function Buttons

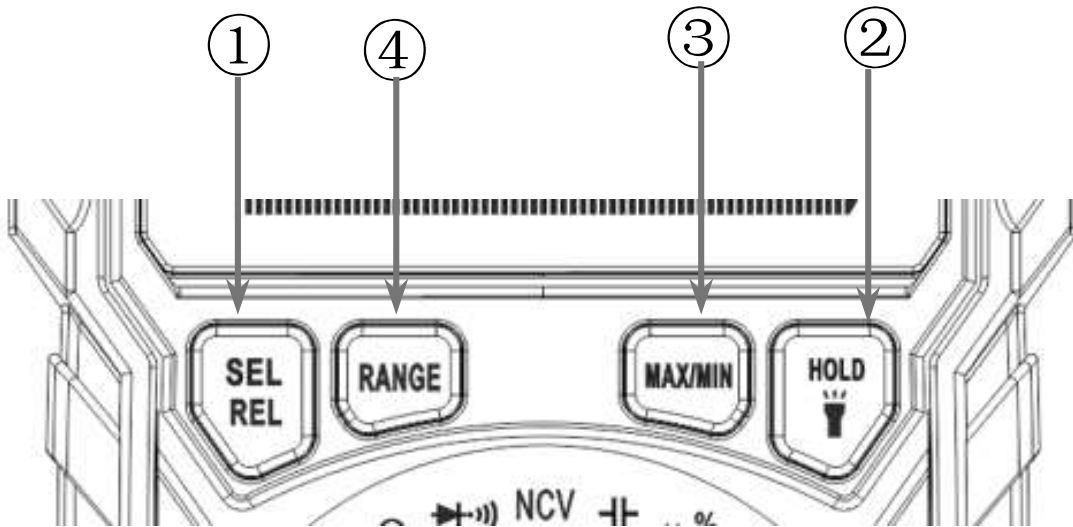

①	<p>Selects alternate measurement modes on a rotary switch setting, including:</p> <ol style="list-style-type: none"><li>1. Frequency/Duty Cycle</li><li>2. DC mA / AC mA</li><li>3. DC <math>\mu</math>A / AC <math>\mu</math>A</li><li>4. DC A / AC A</li><li>5. Diode / Continuity</li><li>6. DC mV / AC mV</li><li>7. AC+DC Voltage / DC Voltage</li><li>8. Press and hold for 2 seconds to enter REL model, press again to exit this mode.</li></ol>
②	<p>Push once to hold the current reading on the display; push again to continue normal operation. Push for more than 2 seconds to turn on the backlight; long-push again to turn off or the backlight automatically turns off after 2 minutes.</p>

③	Push to toggle between the MAX and the MIN mode. To exit MAX/MIN mode, push the button for more than 2 seconds.
④	Press to enter the manual range mode, you can choose the appropriate range according to the measured signal size; If you want to exit, hold down the button for more than 2 seconds. The screen will display "AUTO".



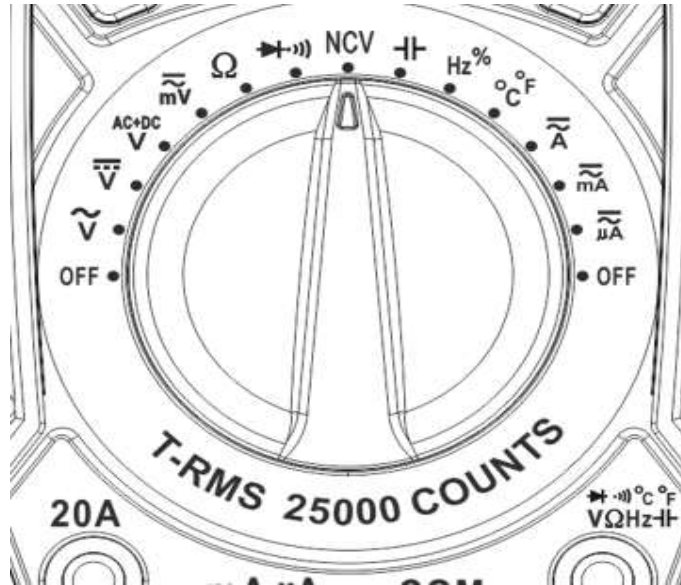







# Rotary Switch



**OFF**

Turn off the product at this position.



- The product automatically powers off after 15 minutes of inactivity.
- The built-in beeper beeps 5 times 1 minute before auto power off.
- To restart the product from auto power off, press the SELECT button or turn the rotary switch back to the OFF position and then to a needed position.
- To disable the Auto Power Off function, hold down the SELECT button when turning on the product, you will hear four beeps if you have successfully disabled the function.

	AC voltage ≤ 750V AC
	DC current: ≤ 1000V DC
	AC+DC voltage
	A/DC voltage: ≤ 250mV AC DC
	Resistance: ≤ 250MΩ
	Continuity, Diode
	Non-contact voltage
	Capacitance: ≤ 99.99mF
	Frequency: ≤ 10MHz
	Celsius: -20~1000, Fahrenheit: -4~1832

$\sim$ A	AC/DC current: $\leq 20A$
$\sim$ mA	AC/DC current mA: $\leq 250mA$
$\sim$ $\mu A$	AC/DC current $\mu A$ : $\leq 2500\mu A$

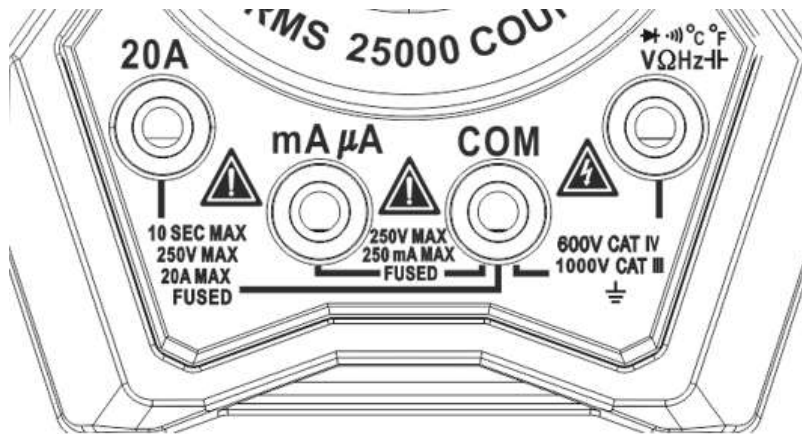
# Input Terminals

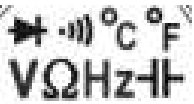

	<p>Input terminal for AC/DC current measurements to 20A.</p>
	<p>Input port for current mA/uA measurement <math>\text{mA} \leq 250\text{mA}</math>, <math>\text{uA} \leq 2500\text{uA}</math></p>
	<p>Common (return) terminal for all measurements.</p>
	<p>Input terminal for the measurements of:</p> <ol style="list-style-type: none"> <li>1. AC/DC voltage</li> <li>2. Resistance</li> <li>3. Capacitance</li> <li>4. Frequency</li> <li>5. Temperature</li> <li>6. Continuity</li> <li>7. Diode</li> <li>8. Duty cycle</li> </ol>

# *Measurements Instruction*

## *Measure AC/DC Voltage*

1. Connect the black test lead to the COM

Terminal and the red lead to the  Terminal.

2. According to the voltage signal to be measured, rotate the dial to select the corresponding voltage gear; Press RANGE button to enter manual range mode, and press SEL button to switch AC/DC in mV mode.

3. Touch the probes to the correct test points of the circuit to measure the voltage.

4. Read the measured voltage on the display.

**\*Do not measure voltage that exceeds the extremes as indicated in the Specifications.**

**\*Do not touch high voltage circuit during measurements.**

## *Measure AC/DC Current*

1. Connect the black test lead to the COM

Terminal and the red lead to the corresponding terminal. (20A or mA/uA).

2. Point the arrow on the knob to the AC/DC A, mA or uA range, depending on the signal size.

3. Break the circuit path to be measured, connect the test leads across the break and apply power.
4. Read the measured current on the display.

**\*Do not measure current that exceeds the extremes as indicated in the Specifications.**

**\*Use the 20A Terminal when you are measuring an unknown current. Then select the test port and gear according to the displayed value.**

**\*Do not input voltage at this setting.**

### *Measure Resistance*

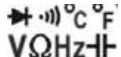
1. Connect the black test lead to the COM Terminal and the test lead to the  Terminal.
2. Rotate the dial to the  $\Omega$  mode.
3. Touch the probes to the desired test points of the circuit to measure the resistance.
4. Read the measured resistance on the display.

**\*Disconnect circuit power and discharge all capacitors before you test resistance.**

**\*Do not input voltage at this setting.**

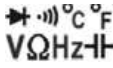

## *Measure continuity*

1. Connect the black test lead to the COM Terminal and the red lead to the  Terminal.
2. Turn the rotary switch to Diode/Continuity mode , then press the SEL button.
3. Touch the probes to the desired test points of the circuit.
4. The built-in beeper will beep when the resistance is lower than  $50\Omega$ , which indicates a short circuit.

**\*Do not input voltage at this setting.**

## *Test Diodes*



1. Connect the black test lead to the COM Terminal and the red lead to the  Terminal.
2. Turn the rotary switch to Diode mode.
3. Connect the red probe to the anode side and the black probe to the cathode side of the diode being tested.
4. Read the forward bias voltage value on the display.

5. If the polarity of the test leads is reversed with diode polarity or the diode is broken, the display reading shows “ OL ”.

**\*Do not input voltage at this setting.**

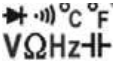

**\*Disconnect circuit power and discharge all capacitors before you test diode.**

### *Measure Capacitance*

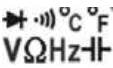

1. Connect the black test lead to the COM Terminal and the red lead to the  Terminal.
2. Turn the rotary switch to .
3. Connect the red probe to the anode side and the black probe to the cathode side of the capacitor being tested.
4. Read the measured capacitance value on the display once the reading is stabilized.

**\*Disconnect circuit power and discharge all capacitors before you test capacitance.**

## ***Measure Frequency***

1. Connect the black test lead to the COM Terminal and the red lead to the  Terminal.
2. Turn the rotary switch to  (applies to high frequency with low voltage); or turn the rotary switch to , press SELECT once to toggle to the Frequency Mode (applies to low frequency with high voltage).
3. Touch the probes to the desired test points.
4. Read the measured frequency value on the display.

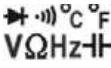
## ***Measure Duty Cycle***

1. Connect the black test lead to the COM Terminal and the red lead to the  Terminal.
2. Turn the rotary switch to , press the Hz % button once to toggle to the Duty Cycle Mode .
3. Touch the probes to the desired test points.
4. Read the measured duty cycle value on the display.

## *Measure Temperature*

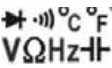
1. Connect the black thermocouple probe to the COM Terminal and the red probe to the  Terminal.
2. Turn the rotary switch to °C/°F mode, and the display will show the room temperature. The main display will show the value of °C, and the vice display will show the value of °F.
3. Touch the probes to the desired test points.
4. Read the measured temperature on the display.

**\*Do not input voltage at this setting.**

## *Test NCV*

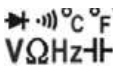
1. Turn the rotary switch to NCV mode, and the display will show “EF”.
2. Hold the product and move it around, the built-in beeper will beep when the inner sensor detects AC voltage nearby. The stronger the voltage is, the quicker the beeper beeps.
3. If the red test lead is inserted into the  alone, and the probe of the test lead is used to contact the mains power plug, if the buzzer alarm is strong, it is the live wire, otherwise the earth wire or the neutral wire.

## *AC+DC Voltage Measurement*

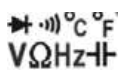
1. Rotate the dial to the  mode, then connect the black test lead to the COM Terminal and the red lead to the  Terminal.
2. Touch the probes to the correct test points of the circuit.
3. Read the measured voltage on the display. The main display will show the value of DC voltage, and the vice display will show the value of AC voltage.
4. Press the SEL to read the value of AC+DC Voltage.

**\*Do not measure voltage that exceeds the extremes as indicated in the Specifications.**

**\*Do not touch high voltage circuit during measurements.**

## ***Maintenance***

Beyond replacing batteries and fuses, do not attempt to repair or service the product unless you are qualified to do so and have the relevant calibration, performance test, and service instructions.

## ***Clean the Product***

Wipe the product with a damp cloth and mild detergent. Do not use abrasives or solvents. Dirt or moisture in the terminals can affect readings.

\*Remove the input signals before you clean the product.

## ***Replace the Batteries***

When “  ” is shown on the display, batteries shall be replaced as below:

1. Remove the test leads and turn off the product before replacing the batteries.
2. Loosen the screw on the battery door and remove the battery door.
3. Replace the used batteries with new batteries of the same type.
4. Place the battery door back and fasten the screw.

## ***Replace the Fuses***

When a fuse is blown or do not work properly, it shall be replaced as below:

1. Remove the test leads and turn off the product before replacing the fuse.
2. Loosen the four screws on the back cover and the screw on the battery door, then remove the battery door and the back cover.
3. Replace the fuse with a new fuse of the same type.
4. Place the back cover and the battery door back and fasten the screws.

## **Specifications**

<b><i>Environmental Specifications</i></b>		
Operating	Temperature	0~40°C
	Humidity	< 75%
Storage	Temperature	-20~60°C
	Humidity	< 80%

## ***General Specifications***

Display (LCD)	25000 counts
Ranging	Auto/Manual
Material	ABS/PVC
Update Rate	3 times/second
Ture RMS	√
Data Hold	√
Backlight	√
Low Battery Indication	√
Auto Power Off	√

## ***Mechanical Specifications***

Dimension	180*90*50mm
Weight	384g (no battery)
Battery Type	1.5V AA Battery * 3
Warranty	One year



# Electrical Specifications

<i>Function</i>	<i>Range</i>	<i>Resolution</i>	<i>Accuracy</i>
DC Voltage (mV)	25.000mV	0.001mV	$\pm (0.05\%+3)$
	250.00mV	0.01mV	
DC Voltage (V)	2.5000V	0.0001V	$\pm (0.05\%+3)$
	25.000V	0.001V	
	250.00V	0.01V	
	1000.0V	0.1V	
AC Voltage (mV)	25.000mV	0.001mV	$\pm (0.3\%+3)$
	250.00mV	0.01mV	
AC Voltage (V)	2.5000V	0.0001V	
	25.000V	0.001V	
	250.00V	0.01V	
	750.0V	0.1V	

<i>Function</i>	<i>Range</i>	<i>Resolution</i>	<i>Accuracy</i>
AC+DC voltage (DC)	2.5000V	0.0001V	$\pm (0.5\%+3)$
	25.000V	0.001V	
	250.00V	0.01V	
	1000.0V	0.1V	
AC+DC voltage (AC)	2.500V	0.001V	$\pm (1.0\%+3)$
	25.00V	0.01V	
	250.0V	0.1V	
	750V	1V	
AC+DC voltage (AC+DC)	2.5000V	0.0001V	$\pm (1.5\%+3)$
	25.000V	0.001V	
	250.00V	0.01V	
	1000.0V	0.1V	

<i>Function</i>	<i>Range</i>	<i>Resolution</i>	<i>Accuracy</i>
DC Current (A)	2.5000A	0.0001A	$\pm (0.5\%+3)$
	20.000A	0.001A	
DC Current (mA)	25.000mA	0.001mA	
	250.00mA	0.01mA	
DC Current ( $\mu$ A)	250.00 $\mu$ A	0.01 $\mu$ A	$\pm (0.5\%+3)$
	2500.0 $\mu$ A	0.1 $\mu$ A	
AC Current (A)	2.5000A	0.0001A	$\pm (0.8\%+3)$
	20.000A	0.001A	
AC Current (mA)	25.000mA	0.001mA	
	250.00mA	0.01mA	
AC Current ( $\mu$ A)	250.00 $\mu$ A	0.01 $\mu$ A	$\pm (0.8\%+3)$
	2500.0 $\mu$ A	0.1 $\mu$ A	
Resistance	250.00 $\Omega$	0.01 $\Omega$	$\pm (0.5\%+3)$
	2.5000k $\Omega$	0.0001k $\Omega$	$\pm (0.2\%+3)$
	25.000k $\Omega$	0.001k $\Omega$	
	250.00k $\Omega$	0.01k $\Omega$	
	2.5000M $\Omega$	0.0001M $\Omega$	$\pm (1.0\%+3)$
	25.00M $\Omega$	0.01M $\Omega$	
	250.0M $\Omega$	0.1M $\Omega$	$\pm (5\%+5)$

<i>Function</i>	<i>Range</i>	<i>Resolution</i>	<i>Accuracy</i>
Capacitance	9.999nF	0.001nF	$\pm(5.0\%+20)$
	99.99nF	0.01nF	$\pm(2.0\%+5)$
	999.9nF	0.1nF	
	9.999 $\mu$ F	0.001 $\mu$ F	
	99.99 $\mu$ F	0.01 $\mu$ F	
	999.9 $\mu$ F	0.1 $\mu$ F	$\pm(5.0\%+5)$
	9.999mF	0.001mF	
	99.99mF	0.01mF	$\pm(5.0\%+20)$
Frequency	250.00Hz	0.01Hz	$\pm(0.1\%+2)$
	2.5000KHz	0.0001KHz	
	25.000KHz	0.001KHz	
	250.00KHz	0.01KHz	
	2.5000MHz	0.0001MHz	
	10.000MHz	0.001MHz	
Duty Cycle	1%~99%	0.1%	$\pm(0.1\%+2)$

<i>Function</i>	<i>Range</i>	<i>Resolution</i>	<i>Accuracy</i>
Temperature	(-20~1000)°C	1°C	±(3%+5)
	(-4~1832)°F	1°F	
Diode	√		
Continuity	√		
NCV	√		
AC+DC voltage measurement	AC+DC 1V~1000V		

